

SFU4302MCX



Category	Compact 24"
Product family	Oven
Power supply	Electrical
Power supply	Electricity
Cooking method	Combi Microwave
Cleaning system	VaporClean
EAN code	8017709250775



Aesthetic

Aesthetics	Classic	Silkscreen color	Black
Color	Stainless steel	Silkscreen type	Symbols
Finishing	Fingerprint-proof	Door	With 2 horizontal fascias
Design	Flat	Handle	Classic
Material	Stainless steel	Handle color	Stainless steel
Stainless steel type	Brushed	Logo	Embossed
Glass type	Eclipse		









Controls

Display technology	LCD	Control knobs	Classic
Controls setting	Control knobs	Controls color	Stainless steel effect
No. of controls	2		





Programs / Functions

No. of cooking functions	13
Automatic programmes	20





Traditional cooking functions

 Static	 Fan-assisted	 True European convection
 Turbo	 Eco	 Large grill
 Fan grill (large)	 Convection bottom	

Microwave functions

 Microwave	 Fan-assisted	 True European convection
 Microwave + Grill	 Warming and re-generation	

Other functions

 Defrost by time	 Defrost by weight	 Proof
 Sabbath		

Cleaning functions

 Vapor Clean
--

Options

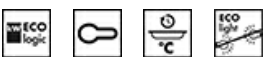

Time-setting options	Delayed start and automatic shut-off when cooking ends	Child safety lock	Yes
Minute minder	Yes	Other options	Keep-warm, Eco light, Quick start
Timer	1	Showroom mode	Yes
Limited power consumption option	Yes		

Technical Features



Minimum Temperature	86 °F	Heating elements stop when door is opened	Yes
Maximum temperature	482 °F	Door opening	Standard opening
No. of shelves	3	Door	Cool-touch door
Shelves type	Metal racks	Total no. of door glasses	3
Tilting grill	Yes	Microwave stops when door is opened	Yes
No. of lights	2	Soft Close	Yes
Lighting	Halogen	Safety thermostat	Yes
Light power	40 W	Cooling system	Tangential
Light on when door is open	Yes		

Lower heating element power 1000 W
 Grill element - power 2000 W
 Circular heating element - Power 1400 W

Cooling duct Single
 Temperature control Electronic
 Cavity material EverClean enamel
 Microwave screen protection Yes

Performance / Energy Label



Volume of the cavity 1.41 cu. ft.
 Number of cavities 1

Microwave effective power 1000 W

Accessories Included



Rack with back stop 1
 Insert grid 1

Glass tray 1
 Telescopic Guide rails, partial Extraction 1

Electrical Connection

Voltage 230 V
 Nominal power 3400 W
 Voltage 120/208 V

Current 13 A
 Frequency 60 Hz
 Power cord length 45 1/4 "

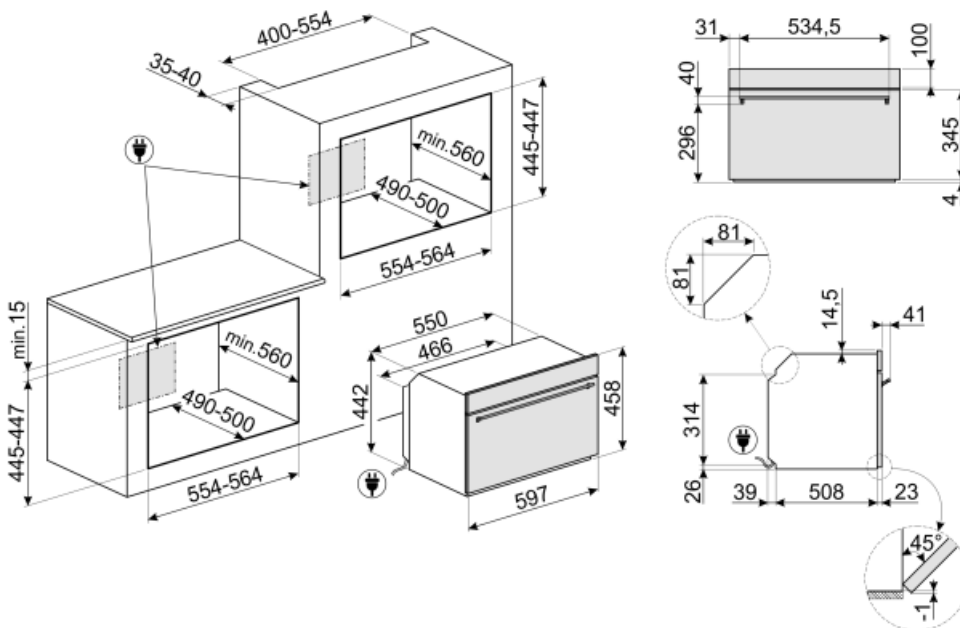

Not included accessories

GTP

Partial-extension telescopic guides
 Length: 14" Extraction: 11 1/4" Material:
 Stainless steel AISI 430 polished



KP43M

Suitable for microwave ovens and combination microwave ovens. To install KP43M a technical intervention is required. As the kit is intended for MWO ovens, for safety reasons the substitution of the door can be performed just by a qualified personell



KIT370X

27" Trim kit for Classic compact ovens



GTT

Total-extension telescopic guides
 Length: 14" Extraction: 16.5" Material:
 Stainless steel AISI 430 polished



KIT330X

30" Trim kit for Classic compact ovens



PR3845X

Antifingerprint stainless steel. Cover for furniture in column installation of more ovens



BN620-1

Enamelled tray, 20mm deep



PALPZ

Pizza shovel with fold away handle
 width: 315mm length : 325mm





































BN640

Enamelled tray, 40mm deep



Symbols glossary (TT)

 <p>Child lock: some models are fitted with a device to lock the programme/cycle so it cannot be accidentally changed.</p>	 <p>Combination microwave: This oven allows to combine two different ways of cooking (Traditional with microwaves). Combined ovens increase cooking opportunities, while providing maximum flexibility of household appliances.</p>
 <p>Air cooling system: to ensure a safe surface temperatures.</p>	 <p>Defrost by time: with this function the time of thawing of foods are determined automatically.</p>
 <p>Defrost by weight: With this function the defrosting time is determined</p>	 <p>Triple glazed doors: Number of glazed doors.</p>
 <p>Automatic lighting switches off: for greater energy savings, the lighting switches off automatically after one minute from the start of cooking.</p>	 <p>Electric</p>
 <p>Enamel interior: The enamel interior of all Smeg ovens have a special antacid lining which helps keep the interior clean by reducing the amount of cooking grease adhering to it.</p>	 <p>Circogas: In gas ovens the fan distributes the heat quickly and evenly throughout the oven cavity, avoiding flavour transfer when cooking a number of different dishes at the same time. In electric ovens this combination completes cooking more quickly of foods that are ready on the surface, but that require more cooking inside, without further browning.</p>
 <p>Fan with upper and lower elements: The elements combined with the fan aim to provide more uniform heat, a similar method to conventional cooking, so pre-heat is required. Most suitable for items requiring slow cooking methods.</p>	 <p>Upper and lower element only: a traditional cooking method best suited for single items located in the centre of the oven. the top pf the oven will always be hottest. Ideal for roast, fruit cakes, bread etc.</p>
 <p>Circulaire: The combination of the fan and circular element around it gives a hot air cooking method. This provides many benefits including no preheat if cook time is more than 20 minutes, no flavour transfer when cooking different foods at the same time, less energy, and shorter cook times. Good for all types of food.</p>	 <p>ECO: The combination of the grill, fan and lower element is particularly suitable for cooking small quantities of food.</p>
 <p>Grill element: Using of grill gives excellent results when cooking meat of medium and small portions, especially when combined with a rotisserie (where possible). Also ideal for cooking sausages and bacon.</p>	 <p>Fan with grill element: The fan reduces the fierce heat from the grill, providing an excellent method of grilling various foods, chops, steaks, sausages etc. giving even browning and heat distribution, without drying out the food. The top two levels recommended for use, and the lower part of the oven can be used to keep items warm at the same time, an excellent facility when cooking a grilled breakfast. Half grill (centre portion only) is ideal for small quantities of food.</p>

- | | |
|--|---|
|  <p>Microwave: Penetrating straight into the food, microwaves cook very quickly and with considerable energy savings. Suitable for cooking without fat, they are also able to thaw and heat food without altering its original appearance and aroma. The microwave function can also be combined with conventional functions with all the resulting advantages. Ideal for all types of food.</p> |  <p>Cooking with the simultaneous use of the heating element in combination with fan and microwave supply.</p> |
|  <p>Microwave + grill element: The use of the grill results in a perfect browning of the surface of the food. The action of microwaves allows instead of cooking in a short time the internal part of the food.</p> |  <p>Fan combined with traditional cooking, where heat is generated from above and below, provides uniform heat. Adding the microwave function allows the same cooking results in less time.</p> |
|  <p>This function can reheat precooked dishes, without becoming dry or hard.</p> |  <p>Circulaire with upper and lower elements: The use of the fan with both elements allows food to be cooked quickly and effectively, ideal for large joints that require thorough cooking. It offers a similar result to rotisserie, moving the heat around the food, instead of moving the food itself, enabling any size or shape to be cooked.</p> |
|  <p>Compact appliances with a height of 45 cm - perfect solution to meet the functional requirements of kitchen sets of small height. Available in several types and in different styles.</p> |  <p>KEEP_WARM_72dpi</p> |
|  <p>Side lights: Two opposing side lights increase visibility inside the oven.</p> |  <p>ECO-logic: option allows you to restrict the power limit of the appliance real energy saving.</p> |
|  <p>Air at 40°C provides the perfect environment for proving yeast type dough mixes. Simply select the function and place dough in the cavity for allotted</p> |  <p>Sabbath: This function allows you to cook food during the Sabbath, the Holiday of rest in the Jewish religion, respecting the precepts. The oven works</p> |
|  <p>The oven cavity has 3 different cooking levels.</p> |  <p>Soft close: all models are equipped with advanced function of smooth closing of the door, which allows the device to close smoothly and quietly.</p> |
|  <p>Telescopic rails: allow you to pull out the dish and check it without having to remove it from the oven entirely.</p> |  <p>Electronic control: Allows you to maintain temperature inside the oven with the precision 2-3 ° C. This enables to cook meals that are very sensitive to temperature changes, such as cakes, souffles, puddings.</p> |
|  <p>Tilting grill: the tilting grill can be easily unhooked to move the heating element and clean the roof of the appliance in one simple step.</p> |  <p>Vapor Clean: a simple cleaning function using steam to loosen deposits in the oven cavity.</p> |
|  <p>The capacity indicates the amount of usable space in the oven cavity in litres.</p> | |