

BlueStar® RCS Series ranges are manufactured to provide the home chef with a cooking experience that can only be matched by a restaurant kitchen environment. From the searing 15,000 BTU open burners to the extra-large convection ovens to the intense 1850° infrared broiler, no compromises were made in the building of the ultimate cooking machine.

PRODUCT FEATURES

- Nova™ power burner delivers 15,000 BTUs of intense heat
- Gentle 130° simmer burner
- Full motion grates
- Extra-large convection oven that accommodates a full size 18" x 26" commercial baking sheet
- 1850° Infrared broiler
- Available in stainless steel only
- Includes standard island trim backguard
- 24" depth for compatibility with standard kitchen cabinetry

SPECIFICATIONS

Range Dimensions: 29.875"W x 24"D x 36.75"H
 Oven Interior: 26.25"W x 20"D x 15"H
 Top Burner Rating: 15,000 BTUs
 Simmer Burner Rating: 9,000 BTUs
 Large Oven Burner Rating: 30,000 BTUs
 Infrared Broiler Rating: 15,000 BTUs
 Electrical Requirements: 120V, 60Hz, 15 AMPs, 1 PH
 (Unit must be on a Non-GFI, dedicated outlet)
 Operating Gas Pressure: NAT: 5.0" WC, LP: 10.0" WC
 Gas Line Size: 1/2"
 Installation Clearance: 0" Side Cabinet, 0" Back Wall



MODEL CONFIGURATION

Four Burners

RCS304BV2

BURNER CONFIGURATION

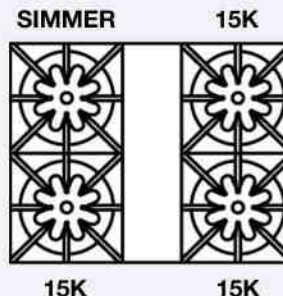

ADDITIONAL CUSTOMIZATION OPTIONS

- Backguards
- Knob colors

All specifications subject to change without notice. Contact BlueStar Customer Service at (800) 449 - 8691 prior to installation or site preparation.

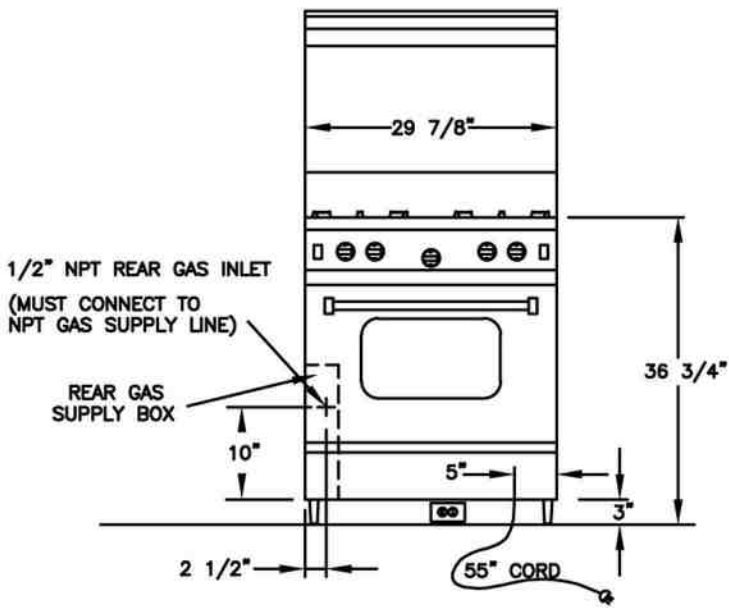

ELECTRICAL CORD LOCATED IN BACK OF UNIT
LOCATION OF ELECTRICAL OUTLET MUST NOT BE HIGHER THAN 3" FROM FLOOR IF LOCATED BEHIND THE UNIT OR CAN BE LOCATED IN AN ADJOINING CABINET.

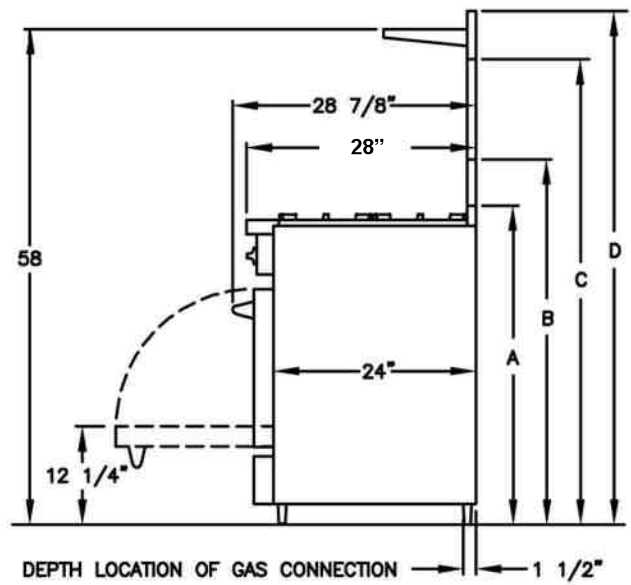

- A - ISLAND TRIM HEIGHT - 38 1/4"
- B - 6" STANDARD BACKGUARD HEIGHT - 43 1/4"
- C - 17" BACKGUARD HEIGHT - 54 1/4"
- D - HIGH SHELF BACKGUARD HEIGHT - 61"

RELATED PRODUCTS

VENTILATION

