

CFEH3054US

FREESTANDING RANGE

30" ELECTRIC



AVAILABLE COLOURS



Stainless

PRODUCT DIMENSIONS

Height (Max.)	36-5/8"
Width	29-7/8"
Depth (Incl. Handle)	29-3/16"

MORE EASY-TO-USE FEATURES

Keep Warm Zone

Keep food warm until everything — and everyone — is ready.

Hidden Bake

Keeping the bottom of your oven clean is easy with a hidden heating element.

One-Touch Self Clean

Your oven cleans itself — so you don't have to. Self-clean options available in 2- and 3-hour cycles.

Store-More™ Storage Drawer

With the Store-More™ Storage Drawer, you will have extra space to store your cookware.

CERTIFICATIONS

A.D.A.- Compliant

When properly installed, this model is A.D.A.-qualified based on the United States Access Board's A.D.A./A.B.A. Accessibility Guidelines and the Department of Justice's 2010 A.D.A. Standards for Accessible Design.



SIGNATURE FEATURES

Upgrade Your Kitchen with a Built-In Look

Upgrade your kitchen and get the look of a built-in range, with the fit of a traditional freestanding range. The Frigidaire® front control freestanding range easily fits into a 30" cutout.

Flexible Five Element Cooktop

Experience ultimate cooking flexibility with a powerful radiant cooktop that has five elements designed to handle all of your cooking needs.

Quick Boil

Get meals on the table faster with our expandable 3,000W element — water boils faster than the traditional setting.

Extra-Large Element

With our extra-large 12" element, you have more flexibility to fit larger pots and pans.

ELEMENTS	SIZE	WATTS
Right Front	12"	2,700
Right Rear	6"	1,200
Left Front	6"/9" Expandable	1,400/3,000
Left Rear	6"	1,200
Centre	Keep Warm Zone	100

CFEH3054US FREESTANDING RANGE

30" ELECTRIC

FRIGIDAIRE

FEATURES

Oven Control/Timing System	Ready-Select® Controls
Surface Type	Black Ceramic Glass
Window	Extra-Large
Exterior Door Finish	Stainless
Handle Design	Stainless
Exterior Finish (Side Panels)	Black
Oven Cleaning System	Self Clean
Drawer Functionality	Storage

OVEN CONTROLS

Bake	Yes
Broil	Yes
Delay Bake	Yes
Delay Start	Yes
Self-Clean	2, 3 Hour
Delay Clean	Yes
Kitchen Timer	Yes
Timed Cook Option	Yes
Auto Oven Shut-Off	12 Hours
Oven Lock-Out	Yes

COOKTOP FEATURES

Right Front Element (Watts)	12" - 2700
Right Rear Element (Watts)	6" - 1200
Left Front Element (Watts)	SpaceWise® Expandable 6"/9" - 1400/3000
Left Rear Element (Watts)	6" - 1200
Centre Element (Watts)	Keep Warm Zone - 100
Hot Surface Indicator Light	Yes
Element "On" Indicator Light	Yes

OVEN FEATURES

Capacity (Cu.Ft.)	5.0
Oven Light	1 Incandescent 40W
Rack Configuration	2 Standard
Baking System	Even Baking Technology
Broiling System	Vari-Broil™ (Hi/Lo)
Bake Element/Broil Element (Watts)	3,500/3,900

CERTIFICATIONS

A.D.A. Compliant ¹	Yes
-------------------------------	-----

SPECIFICATIONS

Oven Interior (H x W x D)	18-5/8" x 24-3/8" x 19-1/8"
Power Supply Connection Location	Middle Bottom Rear
Voltage Rating	240V/208V/60Hz
Connected Load (kW Rating) @ 240/208 Volts	12.5/9.5
Minimum Circuit Required (Amps)	40
Shipping Weight (Approx.)	170 Lbs.

¹When properly installed, this model is A.D.A.-qualified based on the United States Access Board's A.D.A./A.B.A. Accessibility Guidelines and the Department of Justice's 2010 A.D.A. Standards for Accessible Design.

PRODUCT DIMENSIONS

A - Height (Max.)	36-5/8"
B - Width	29-7/8"
C - Depth (Incl. Handle)	29-3/16"
Depth with Door Open 90°	47"

CABINET CUTOUT DIMENSIONS

Height (Standard)	36"
Width (Min.)	30"
Depth (Min.)	24"

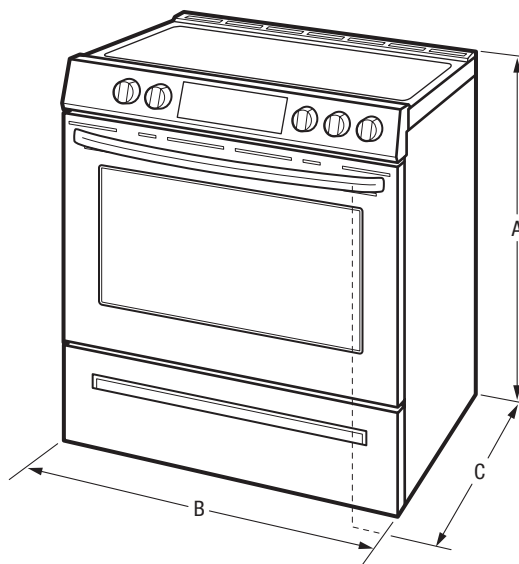

Note: For planning purposes only. Always consult local and national electric, gas and plumbing codes. Refer to Product Installation Guide for detailed installation instructions on the web at frigidaire.ca.
Specifications subject to change. Accessories information available on the web at frigidaire.ca

FRIGIDAIRE

CANADA • 5855 Terry Fox Way • Mississauga, ON L5V 3E4 • 1-800-265-8352 • frigidaire.ca

CFEH3054U 09/18
© 2018 Electrolux Major Appliances, NA

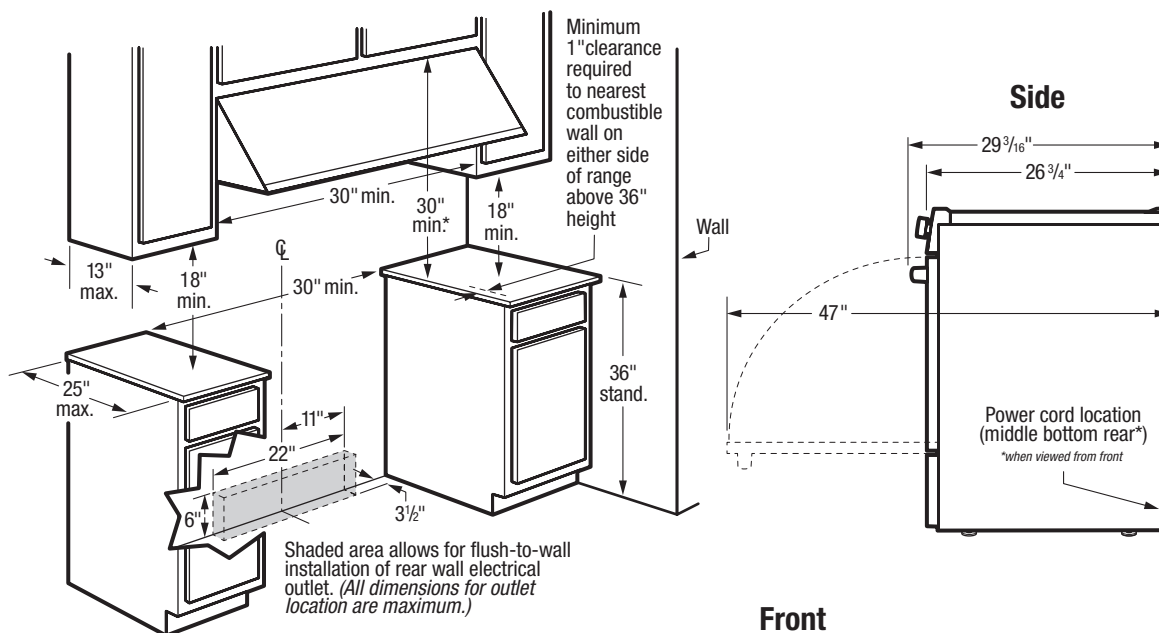

***Note:** 30" minimum clearance between top of cooking surface and bottom of unprotected wood or metal overhead cabinet; or 24" minimum clearance when bottom of wood or metal overhead cabinet is protected by not less than 1/4" flame-retardant millboard covered with not less than No. 28 MSG sheet steel, 0.015" stainless steel, 0.024" aluminum or 0.020" copper. 0" clearance is minimum for rear of range. Follow all dimension requirements provided above to prevent property damage, potential fire hazard, and incorrect countertop and cabinet cuts.

INSTALLATION SPECIFICATIONS

- Product Shipping Weight (approx.) - 170 Lbs.
- Single phase 3- or 4-wire cable, 120/240 or 120/208 Volt, 60 Hertz, fused on both sides of line with ground.
- Connected Load (kW Rating) @ 240/208 Volts = 12.5/9.5 kW
- Recommended Circuit Breaker - 40 Amps
- Always consult local and national electric codes.
- Make sure wall coverings around range can withstand heat generated by range.
- Floor beneath range MUST be solid and level.
- Overhead cabinetry should not exceed a 13" maximum depth.
- Absolute minimum horizontal distance between overhead cabinets installed to either side of appliance must be no less than maximum width of appliance.
- Range can be installed flush to wall with 0" minimum rear clearance.
- Minimum 1" clearance required from edge of rangetop to nearest combustible wall on either side of range above 36" height.
- Allow 30" minimum clearance between top of cooking surface and bottom of unprotected wood or metal overhead cabinet; or 24" minimum clearance when bottom of wood or metal overhead cabinet is protected by not less than 1/4" flame-retardant millboard covered with not less than no. 28 MSG sheet steel, 0.015" stainless steel, 0.024" aluminum or 0.020" copper.
- To reduce risk of fire when using overhead cabinetry, install range hood that projects horizontally a recommended minimum of 5" beyond bottom of cabinets.
- Follow all dimension requirements provided to prevent property damage, potential fire hazard, and incorrect countertop and cabinet cuts.

