



TRUE RESIDENTIAL®

THE TRUE 42 / 48

INSTALLATION GUIDE

True®

PRESERVE THE MOMENT™

THANK YOU

FOR YOUR PURCHASE

INDEX

OWNERSHIP **1**

SAFETY PRECAUTIONS **1**

DISPOSAL OF OLD REFRIGERATOR **1**

CFC DISPOSAL **1**

SITE PREPARATION **3**

ELECTRICAL REQUIREMENTS **3**

SPECIFICATIONS **7**

ANTI-TIP BRACKET INSTALLATION **11**

LEVELING THE UNIT **11**

BASIC ELECTRONIC CONTROL OPERATIONS **15**

SHELVING **23**

REMOVING THE DOORS **23**

KICK PLATE INSTALLATION **23**

GENERAL MAINTENANCE **27**

STAINLESS STEEL CLEANING AND MAINTENANCE **27**

CONTACT INFORMATION

WARRANTY GUIDE

NOTE:

AS WE STRIVE FOR CONTINUOUS IMPROVEMENTS, FEATURES AND SPECIFICATIONS ARE SUBJECT TO CHANGE WITHOUT NOTICE.

THE TRUE 42 / 48

TR-42SBS-SS-B TR-48SBS-SS-B



*Commercial refrigeration refined for the home, envied in the industry,
and crafted—gorgeously—in America.*

OWNERSHIP

SAFETY PRECAUTIONS

DISPOSAL OF THE OLD REFRIGERATOR

CFC DISPOSAL



PRESERVE THE MOMENT™

OWNERSHIP

TO INSURE THAT YOUR UNIT WORKS PROPERLY FROM THE FIRST DAY, IT MUST BE INSTALLED PROPERLY.

NOTE: WE HIGHLY RECOMMEND A TRAINED REFRIGERATION MECHANIC AND ELECTRICIAN INSTALL YOUR TRUE RESIDENTIAL® CABINET. THE COST OF A PROFESSIONAL INSTALLATION IS MONEY WELL SPENT.

Before you start to install your True Residential® Cabinet, carefully inspect it for freight damage. If damage is discovered, immediately file a claim with the delivery freight carrier. True is not responsible for damage incurred during shipment.

Any questions about the installation please contact your True dealer or True Technical Service Department at 844-746-9423. Please have your model and serial numbers available when you call our Service Department.

SAFETY PRECAUTIONS

- This refrigerator must be properly installed and located in accordance with the installation instructions before it is used.
- Do not allow children to climb, stand or hang on the shelves in the refrigerator. They could seriously injure themselves or damage the refrigerator.
- Do not store or use gasoline or other flammable vapors and liquids in the vicinity of this or any other appliance.
- Keep hands away from the “pinch point” areas (gaps between the doors and between the doors and cabinet). Small areas are not necessarily safe.
- Unplug the refrigerator before cleaning and making repairs.
- Setting temperature control to OFF only removes power from the refrigeration system, it does not remove power from other circuits. For example, temperature control and lights.

NOTE: WE STRONGLY RECOMMEND THAT ANY SERVICING BE PERFORMED BY A QUALIFIED INDIVIDUAL.

PROPER DISPOSAL OF THE OLD REFRIGERATOR

Child entrapment and suffocation are not problems of the past. Junked or abandoned refrigerators are still dangerous...Even if they will sit for “just a few days”. If you are getting rid of your old refrigerator, please follow the instructions below to help prevent accidents.

BEFORE YOU THROW AWAY YOUR OLD REFRIGERATOR OR FREEZER:

- Take off the doors.
- Leave the shelves in place so that children may not easily climb inside.



CFC DISPOSAL

Your old refrigerator may have a cooling system that used CFCs (chlorofluorocarbons). CFCs are believed to harm stratospheric ozone. If you are throwing away your old refrigerator, make sure the CFC refrigerant is removed for proper disposal by a qualified service. If you intentionally release this CFC refrigerant you can be subject to fines and imprisonment under provisions of the environment legislation.

SITE PREPARATION

ELECTRICAL REQUIREMENTS



PRESERVE THE MOMENT™

SITE PREPARATION

- Rough Opening dimensions. (See figure 1 and 2)
- For FLUSH installations the front face of the unit will be flush with the surrounding cabinets. (See figure 3)
- For PROUD (Standard) installations, the front face of the unit will extend beyond cabinets. (See figure 4)

MEASUREMENTS & WEIGHT

	TR-42		TR-48	
	FLUSH	PROUD	FLUSH	PROUD
WIDTH	42 ¹ / ₄ "	41 ³ / ₄ "	48 ¹ / ₄ "	47 ³ / ₄ "
DEPTH	26"	24"	26"	24"
HEIGHT	84 ¹ / ₄ "	84"	84 ¹ / ₄ "	84"
WEIGHT*	720 Lbs	720 Lbs	820 Lbs	820 Lbs
Cord Length	8 feet	8 feet	8 feet	8 feet

* Because of the weight of this unit, it is recommended to consult a flooring expert prior to installation. The flooring beneath the unit should be rated to support at least 150 pounds per square foot.

TR-42

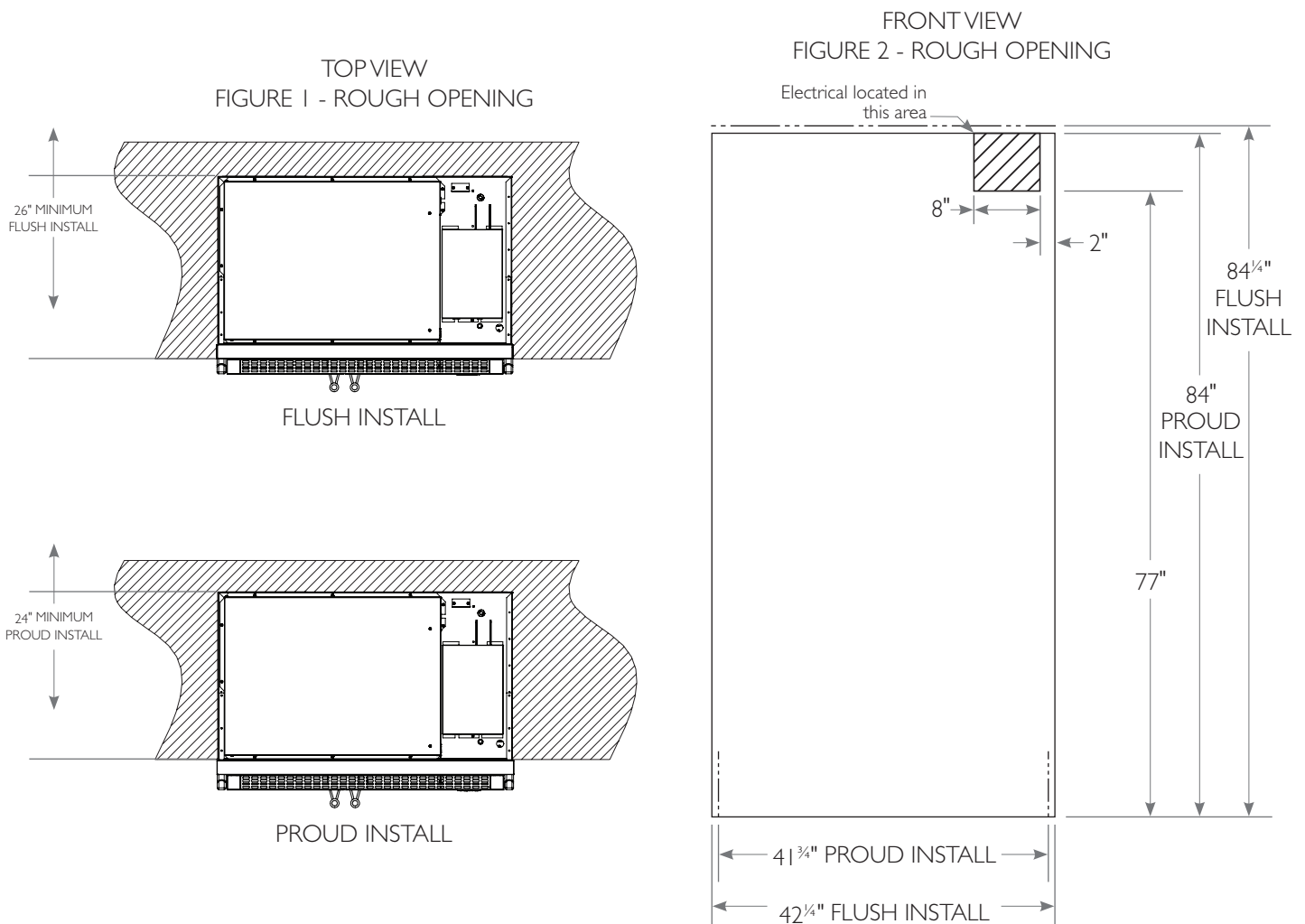

NOTE: DIMENSIONS MAY VARY BY $\pm 1/8$ "

TOPVIEW
FIGURE 3 - FLUSH INSTALLATION

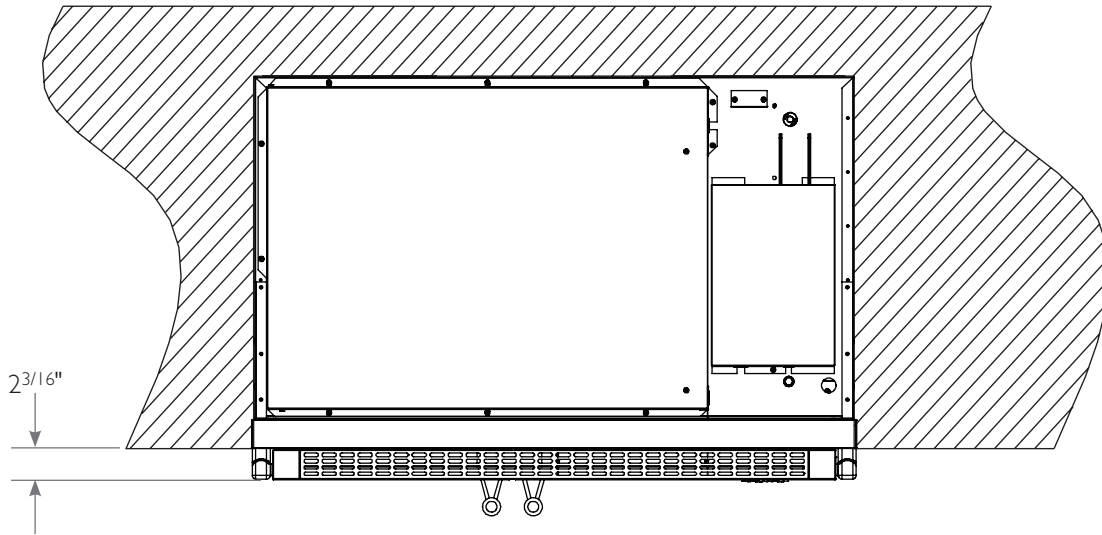

TOPVIEW
FIGURE 4 - PROUD INSTALLATION

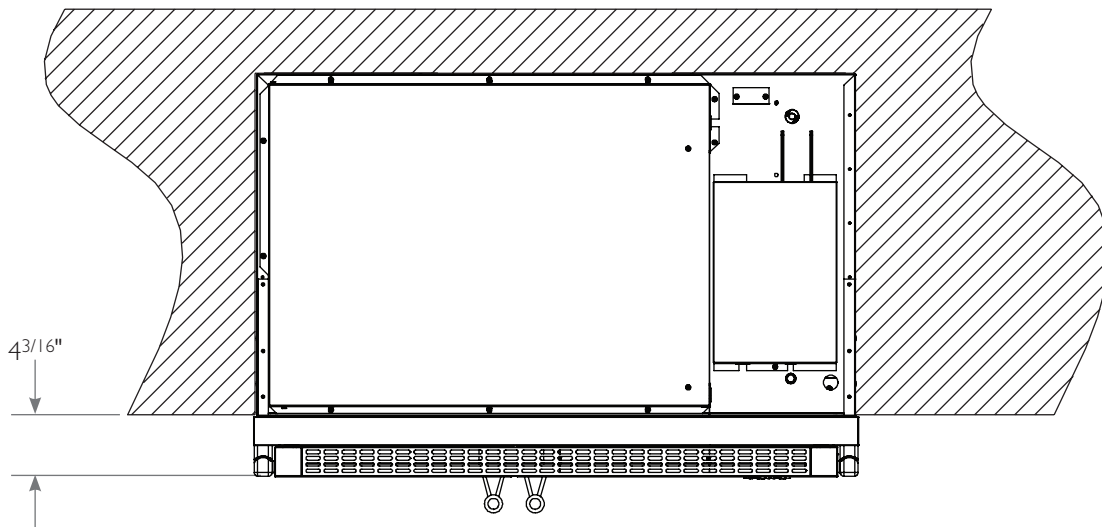

NOTE: DIMENSIONS MAY VARY BY $\pm 1/8$ "

TOP VIEW
FIGURE 1 - ROUGH OPENING

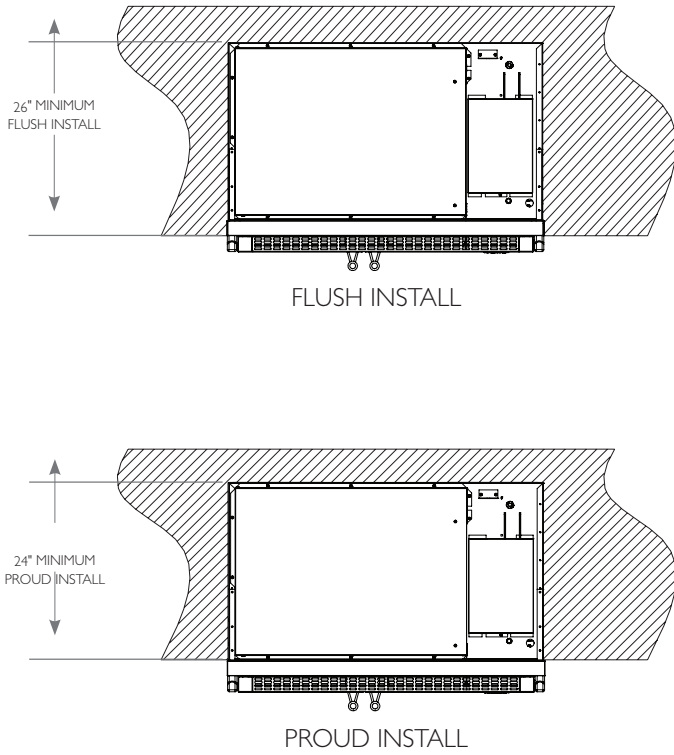

FRONT VIEW
FIGURE 2 - ROUGH OPENING

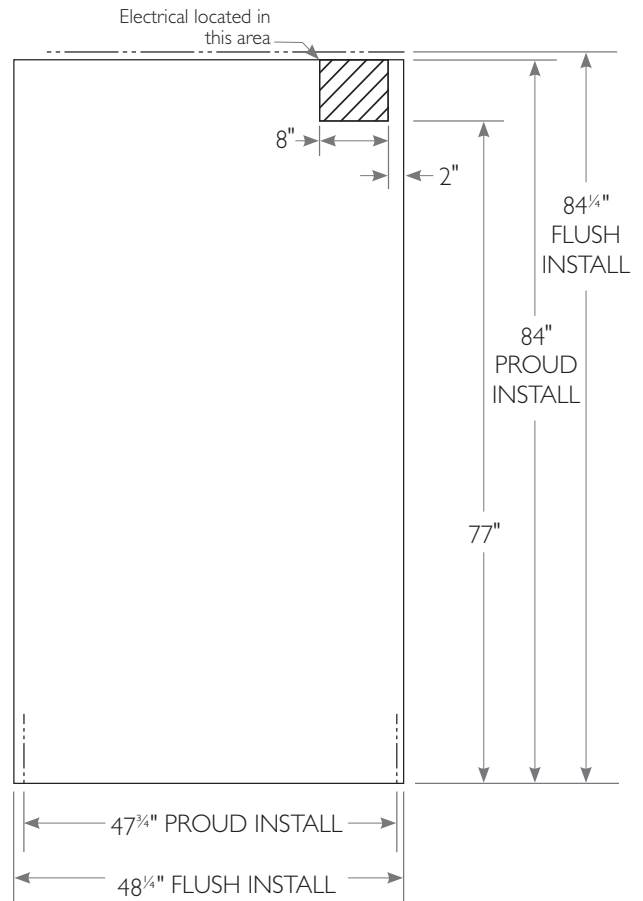

NOTE: DIMENSIONS MAY VARY BY $\pm 1/8"$

TOPVIEW
FIGURE 3 - FLUSH INSTALLATION

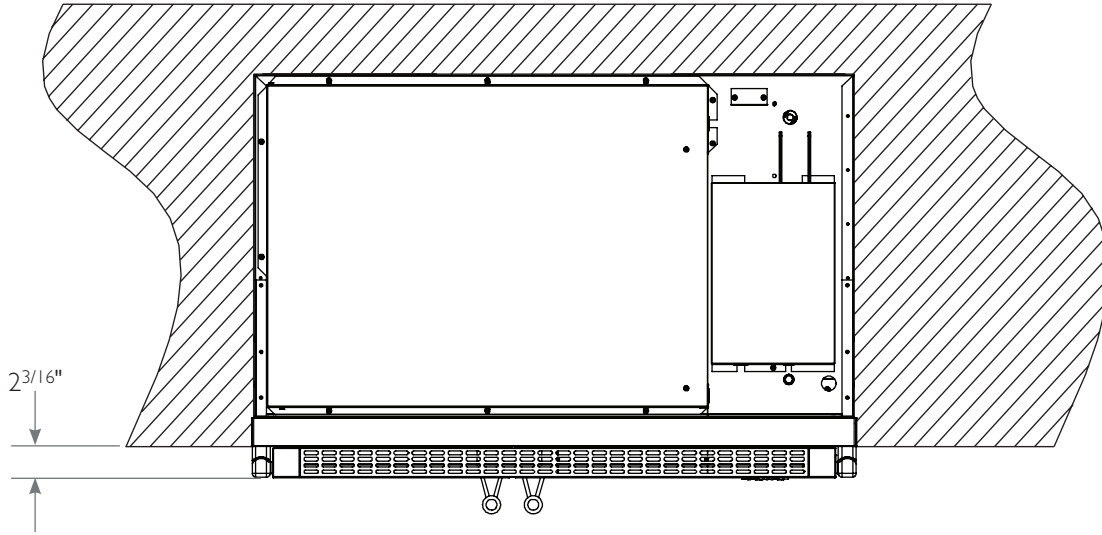

TOPVIEW
FIGURE 4 - PROUD INSTALLATION

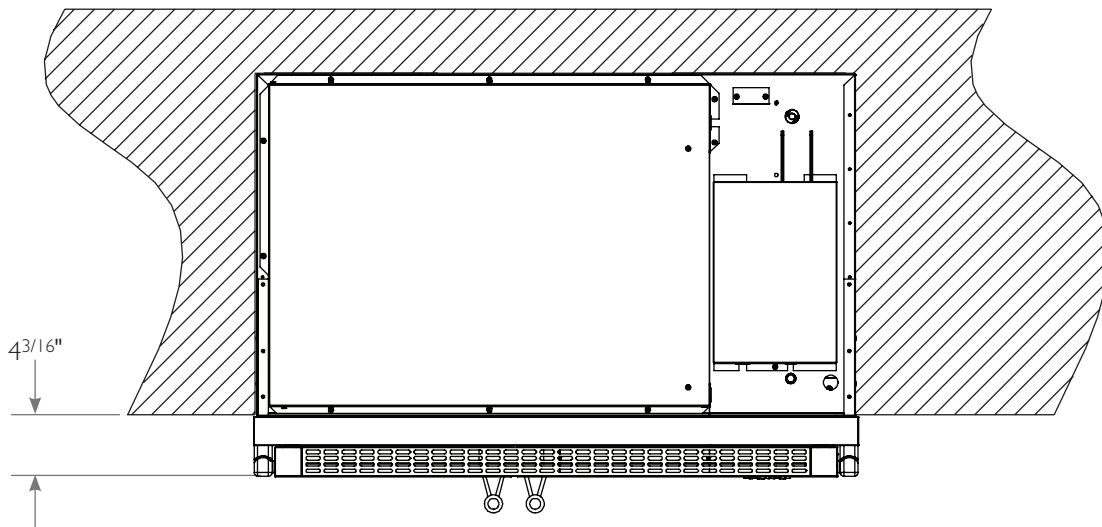

NOTE: DIMENSIONS MAY VARY BY $\pm \frac{1}{8}$ "

ELECTRICAL REQUIREMENTS

For all built-in models, the electrical supply should be located within the shaded area shown in the illustration (See Figure 5). Follow the National Electrical Code and local codes and ordinances when installing the receptacle. A separate circuit, servicing only this appliance is required. A ground fault circuit interrupter (GFCI) is not recommended and may cause interruption of operation.

- **POWER SUPPLY 115 V AC, 60 HZ**
- **CIRCUIT BREAKER 15 AMP**
- **RECEPTACLE 3-PRONG GROUNDING-TYPE**

NOTES:

- **THE OUTLET MUST BE CHECKED BY A QUALIFIED ELECTRICIAN TO BE SURE THAT IT IS WIRED WITH THE CORRECT POLARITY.**
- **VERIFY THAT THE OUTLET IS PROPERLY GROUNDED.**

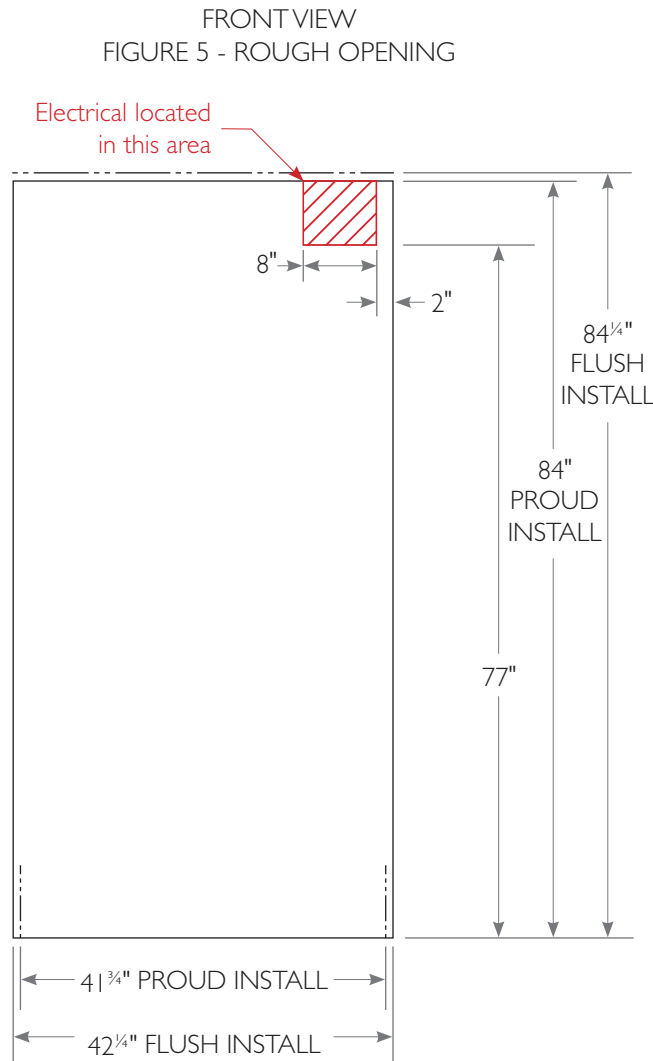

NOTE: DIMENSIONS MAY VARY BY $\pm 1/8$ "

SPECIFICATIONS

TR-42 / TR-48



PRESERVE THE MOMENT™

OVERALL DIMENSIONS - TR-42

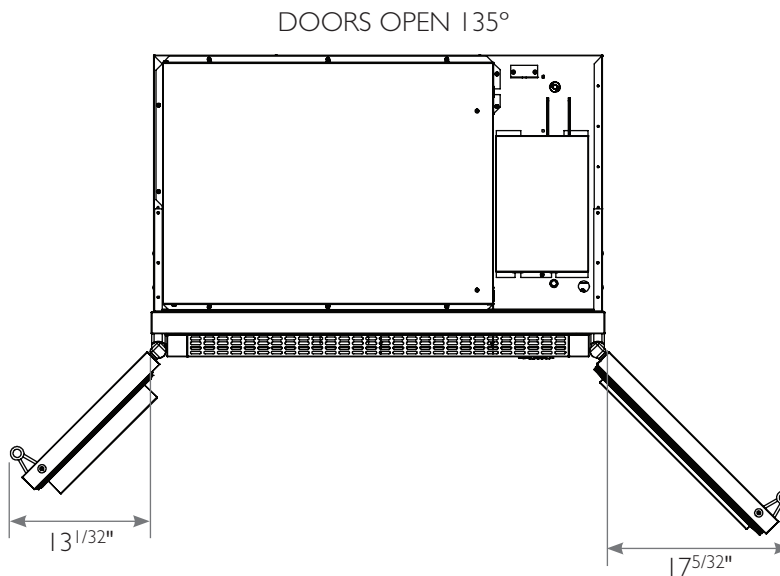
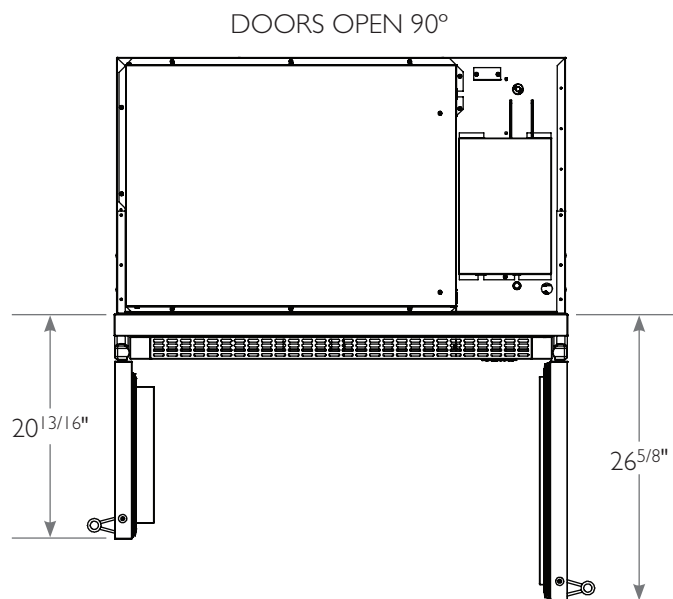
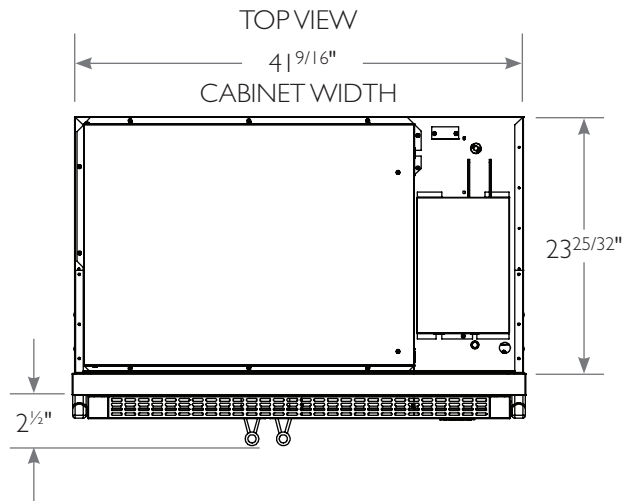

FRONT VIEW

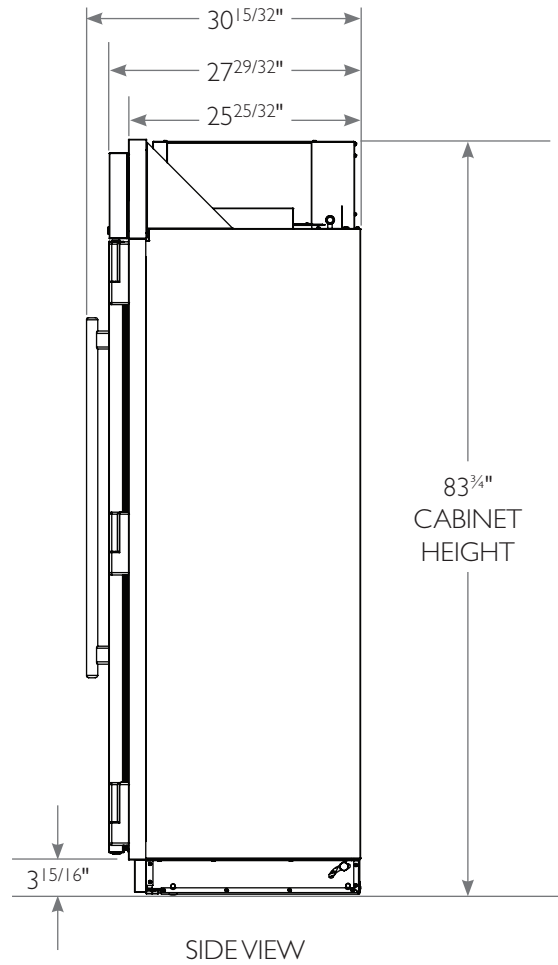
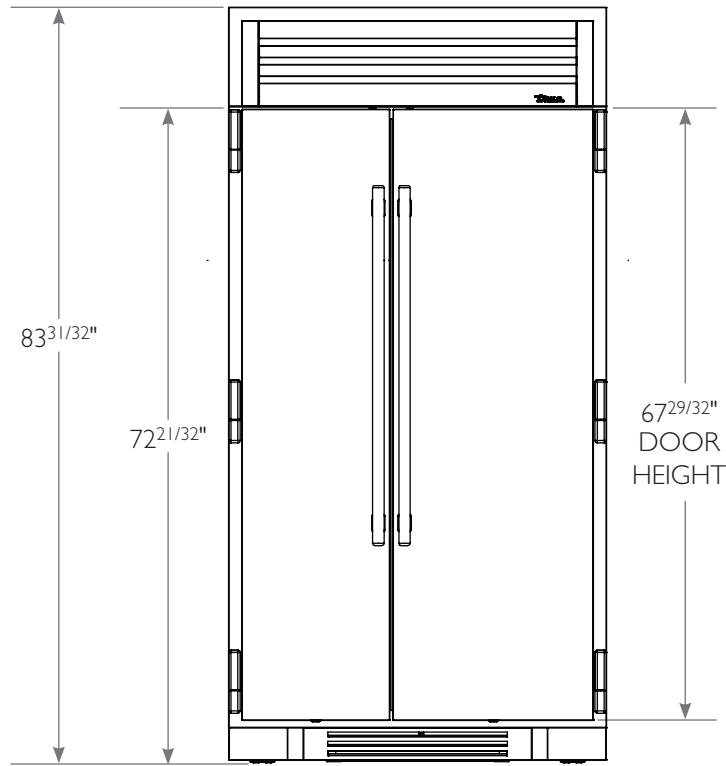

NOTE: DIMENSIONS MAY VARY BY $\pm 1/8$ "

OVERALL DIMENSIONS - TR-48

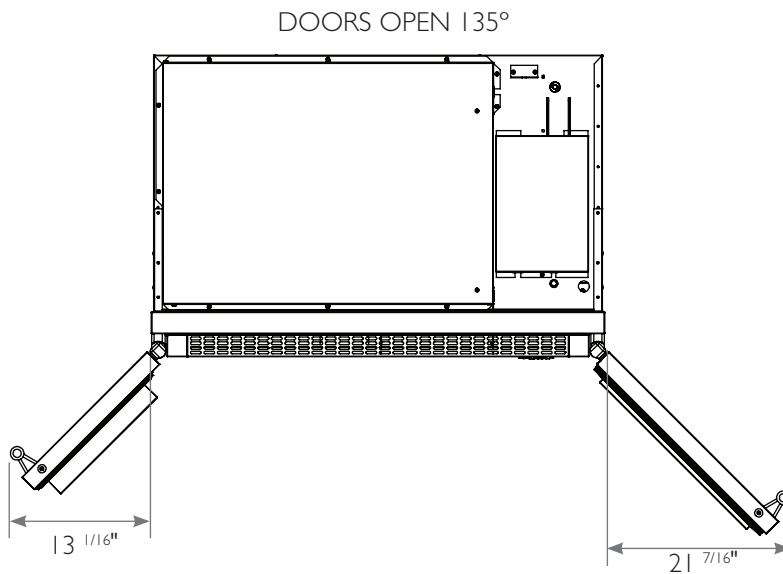
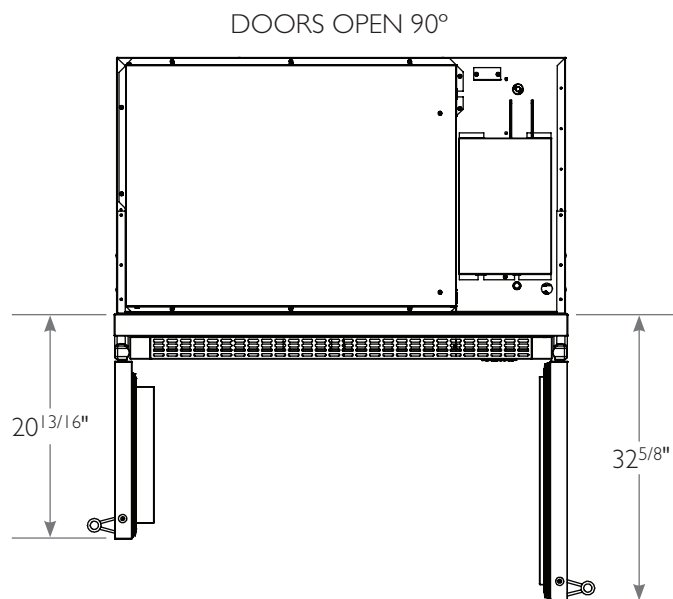
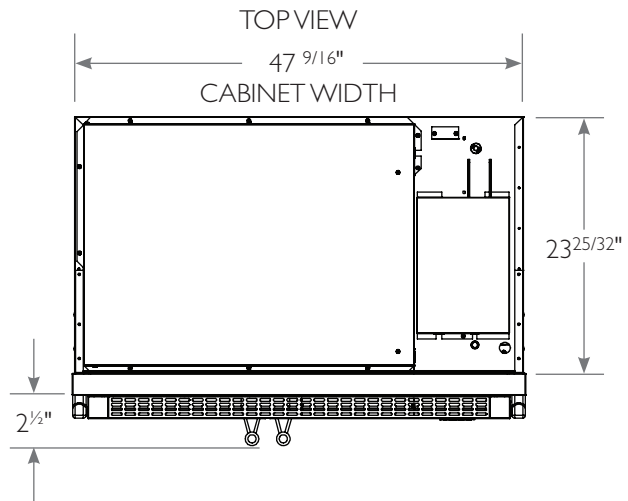

FRONT VIEW

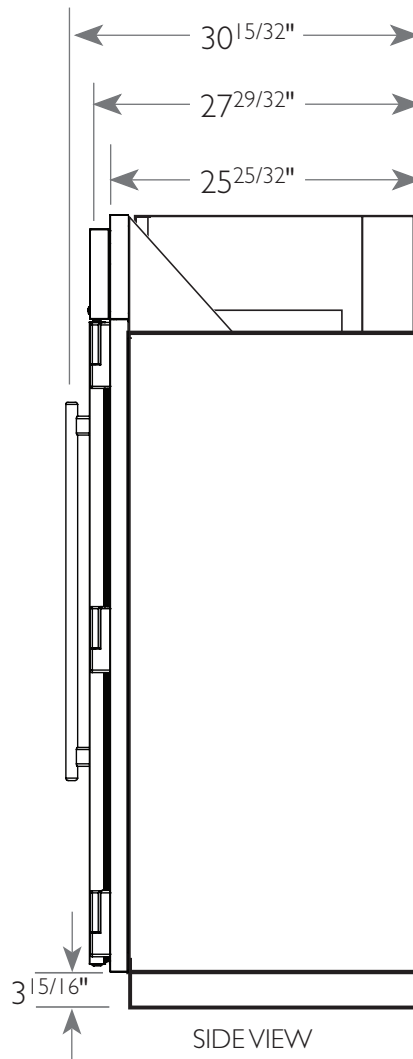
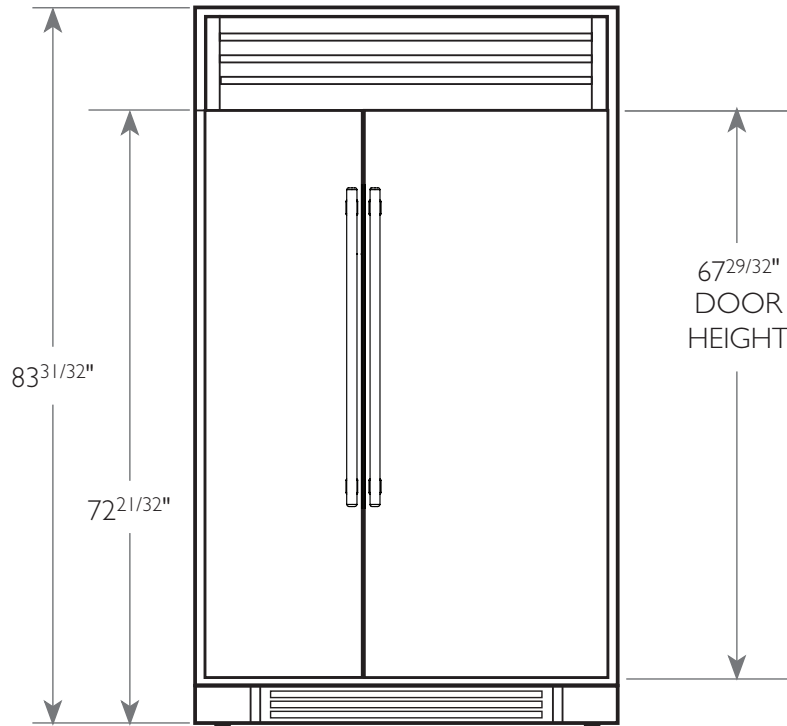

NOTE: DIMENSIONS MAY VARY BY $\pm 1/8$ "

NOTES

ANTI-TIP B RACKET INSTALLATION

LEVELING THE UNIT



PRESERVE THE MOMENT™

ANTI-TIP KIT INSTALLATION

ANTI-TIP BRACKET KIT:

- One (1) anti-tip bracket (Figure 1.1)
- Four (4) masonry 3/16" screws
- Eight (8) wood #12 – 2" screws
- Twelve (12) 1/4" washers

FOR ALL FULL SIZE RESIDENTIAL MODELS, THE ANTI-TIP BRACKET ENGAGES WITH THE REAR LEVELING LEGS TO SECURE THE UNIT. FOLLOW THESE STEPS TO SECURE THE BRACKET BEFORE MOVING THE UNIT INTO FINAL OPERATING POSITION.

1. Determine final location of the unit. For a FLUSH install, measure back 24-31/32" (Dimension A) from the surrounding cabinetry. For a PROUD install, measure back 22-31/32" (Dimension B) from the surrounding cabinetry. For either type of install, place the anti-tip bracket centered in the rough opening.

2. Using the bracket as a guide, drill pilot holes into the floor and wall. It is recommended to secure the bracket to as many floor joists and wall studs as possible.
3. Using the provided screws and washers, secure the bracket to the wall/floor. Adjust the rear rollers to just above their lowest position and move the unit to its final position. Raise the rear rollers a minimum of 1/8" to engage the bracket.

FIGURE 1.1 - ANTI-TIP BRACKET

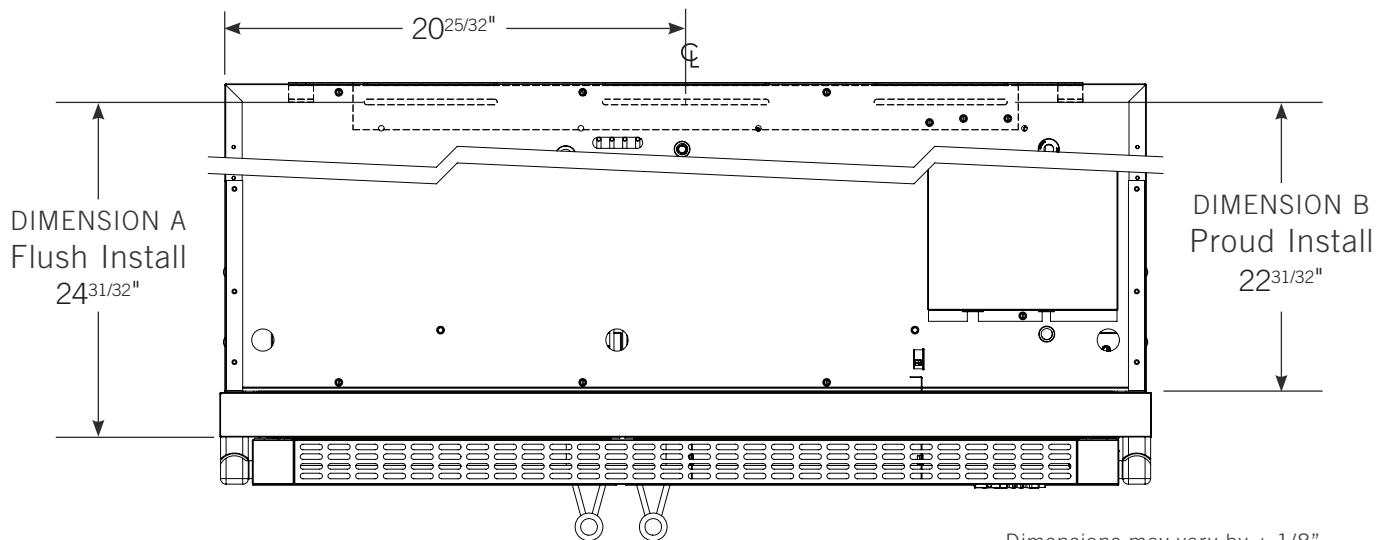
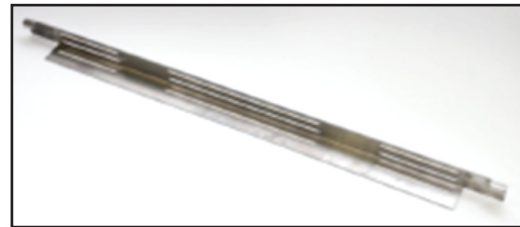

NOTES:

- **BECAUSE OF THE WEIGHT OF THIS UNIT (720 LBS), IT IS RECOMMENDED TO CONSULT A FLOORING EXPERT PRIOR TO INSTALLATION. THE FLOORING BENEATH THE UNIT SHOULD BE RATED TO SUPPORT AT LEAST 150 POUNDS PER SQUARE FOOT.**
- **EIGHT (8) 1/4-20 X 1" LAG BOLTS SECURING THE UNIT TO THE SKID DURING SHIPPING MAY ALSO BE USED ON THE INSTALLATION OF THE ANTI-TIP BRACKET.**



WARNING

TIP OVER HAZARD

A child or adult could tip the refrigerator resulting in property damage or bodily harm. Follow these instructions to properly install the anti-tip device. If the unit is moved, verify the device is properly engaged before normal usage of unit commences.

NOTE: DIMENSIONS MAY VARY BY $\pm 1/8$ "

LEVELING THE UNIT

It is very important that the refrigerator sits level. This will insure that the doors will align and seal properly and that the drain pans will not spill over.

TO LEVEL THE UNIT:

1. PLACE A LEVEL ON THE INTERIOR FLOOR. CHECK AND ADJUST FOR LEVEL FROM FRONT TO BACK, ALSO CHECK AND ADJUST FOR LEVEL FROM RIGHT TO LEFT.
2. ADJUST THE FRONTS USING A SET OF PLIERS OR A WRENCH. (SEE FIGURE 6)
3. ADJUST THE REAR USING A 7/16" SOCKET AND RATCHET. (SEE FIGURE 6) TURN CLOCKWISE TO RAISE THE REAR OF THE UNIT.

FIGURE 6 - LEG ADJUSTMENTS

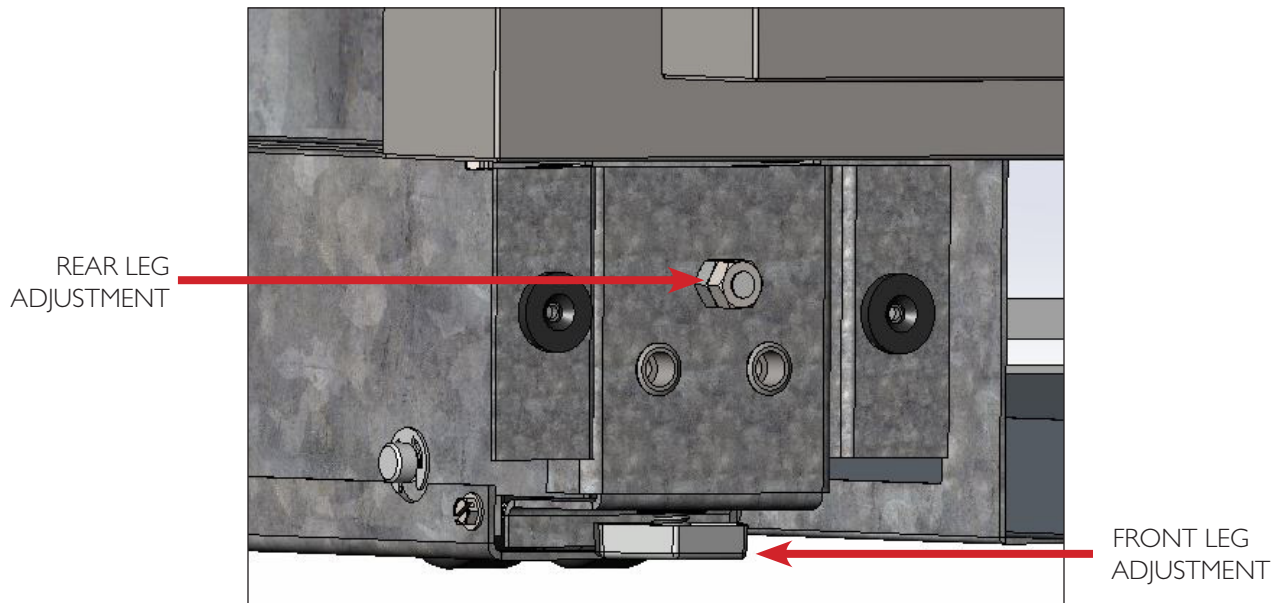

NOTE: DIMENSIONS MAY VARY BY $\pm 1/8$ "

BASIC ELECTRONIC CONTROL OPERATIONS



PRESERVE THE MOMENT™

BASIC ELECTRONIC CONTROL OPERATIONS

The following pages describe the basic input operations performed at the control panel;

- Switching unit ON and OFF
- Adjusting set-point (temperature adjustment)
- Enabling and disabling door ajar alarm feature
- Switching accent lighting systems ON and OFF

PLEASE NOTE THAT THOUGH POSSIBLE TO DISPLAY TEMPERATURES IN FAHRENHEIT OR CELSIUS, IN MOST CASES FAHRENHEIT READINGS ARE SHOWN IN THIS MANUAL.

UNIT ON/OFF

All units are shipped in ON Mode. When electricity is supplied to the appliance, a short power up diagnostics test is initiated followed by one audible beep, the lights energizing and temperature readings appearing in the LCD.

NOTES:

- **WHENEVER THE UNIT IS SWITCHED OFF USING THE POWER KEY, THE WORD “OFF” WILL BE VISIBLE IN THE LCD (SEE FIGURE 7) AS LONG AS THERE IS ELECTRICITY SUPPLIED TO THE APPLIANCE.**
- **WHENEVER THE UNIT IS SWITCHED ON USING THE POWER KEY, THE UNIT EMITS ONE AUDIBLE BEEP, AND THEN TEMPERATURE READINGS WILL APPEAR IN THE LCD. (SEE FIGURE 8).**
- **IF THE UNIT EXPERIENCES ANY PROBLEMS DURING THE POWER UP DIAGNOSTIC TEST, THEN THE APPROPRIATE FAULT CODES WILL BE DISPLAYED. (SEE PAGE 21, FIGURE 13 - NOTIFICATION ALERTS).**



WARNING!

WHEN IN “OFF” MODE, AC LINE VOLTAGE IS STILL PRESENT AT MAIN CONTROL BOARD!

FIGURE 7 - CONTROL PANEL OFF



FIGURE 8 - CONTROL PANEL ON

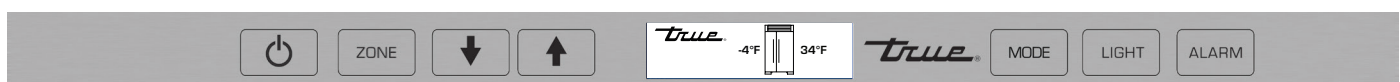

ZONE NAVIGATION (TEMPERATURE ADJUSTMENT)

To adjust set-points, press ZONE for the appropriate compartment, then DOWN or UP key on control panel in multiple key strokes until the desired set-point is achieved (See Figure 9). Each key stroke equals a one degree change and is accompanied by an audible beep. When the desired set-point is reached press the ZONE key until you reach the “HOME” screen, where the current zone temperatures will be displayed.

NOTES:

- THE TEMPERATURE RANGE IN A FREEZER ZONE IS -4°F (-20°C) TO $+4^{\circ}\text{F}$ (-16°C).
- THE TEMPERATURE RANGE IN A REFRIGERATOR ZONE IS $+34^{\circ}\text{F}$ ($+1^{\circ}\text{C}$) TO $+42^{\circ}\text{F}$ ($+6^{\circ}\text{C}$).
- INITIAL FACTORY SET-POINTS ARE 0°F (-18°C) IN A FREEZER ZONE AND 38°F (3°C) IN A REFRIGERATOR ZONE.
- THE INITIAL STROKE OF THE UP OR DOWN KEY WILL CHANGE THE PREVIOUS SET-POINT BY ONE DEGREE.

FIGURE 9 - ADJUSTING SET-POINTS

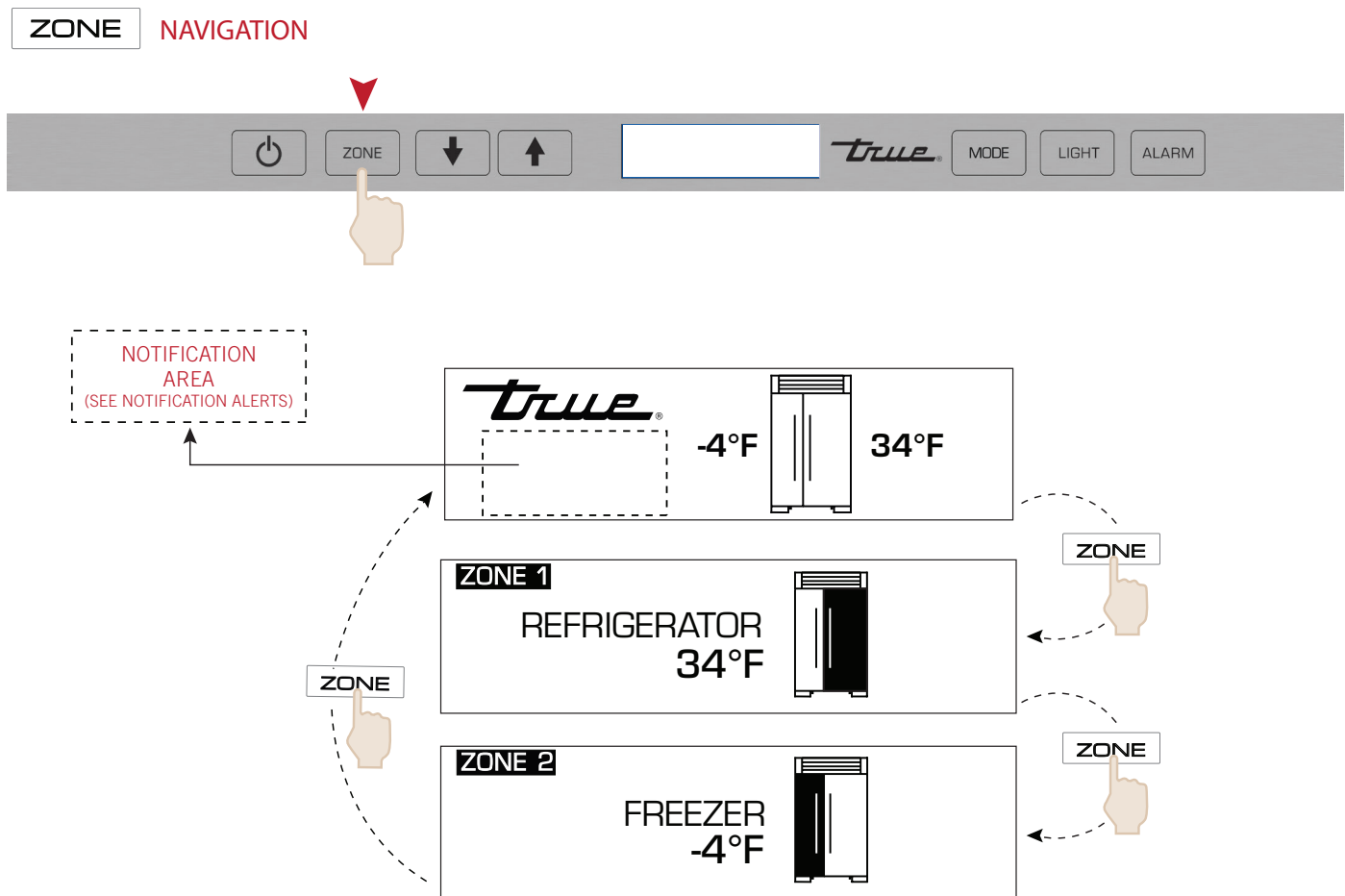

MODE NAVIGATION

The following pages illustrate unique customer input operations performed at the control panel. The input operations described are:

**TEMPERATURE UNIT SELECTION MODE, VACATION MODE, AND HOLIDAY MODE.
(SEE FIGURE 10).**

NOTES: (HOLIDAY MODE)

- **SET-POINTS CANNOT BE CHANGED AND MANUAL DEFROST CANNOT BE INITIATED.**
- **THE FOLLOWING HOLDS TRUE IN ACCORDANCE WITH STAR-K REQUIREMENTS:**
 - Freezer defrosting functions will convert to a fixed time base sequence.
 - The compartment/zone thermistors will still detect cut-in and cut-out, which is the determining factor to start/stop the cooling process, but there will be a random sixteen (16) to twenty-one (21) second delay before cooling begins/ends.
 - The phrase "HOLIDAY MODE ACTIVE" in the LCD remains energized when the door is closed.

FIGURE 10 - MODE NAVIGATION

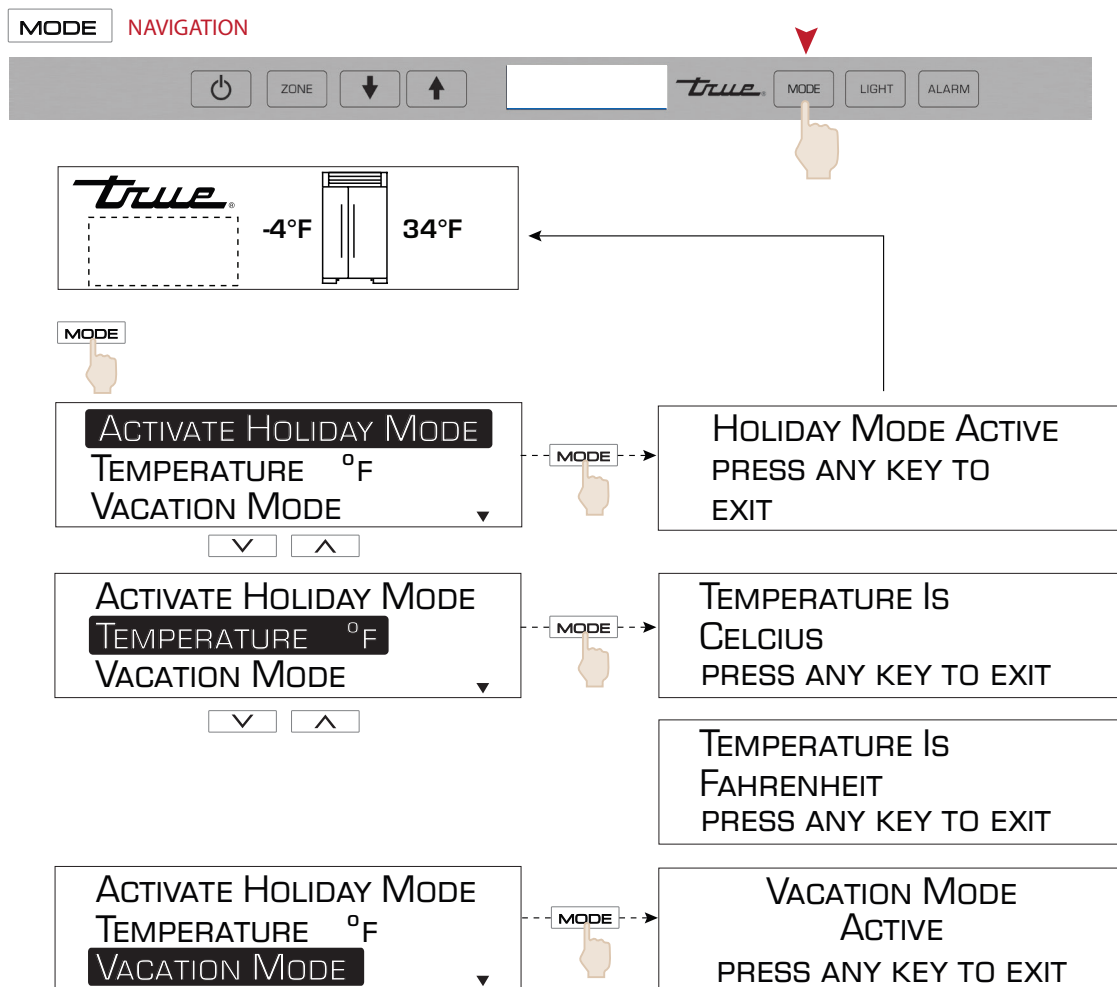

ACCENT LIGHTING SYSTEM

All models are equipped with an accent lighting system in the refrigerator and or freezer compartment(s). To energize the accent lighting system, press the LIGHT key, and navigate to the corresponding compartment, DOOR or ON will appear in the LCD indicating the accent lights are enabled (See Figure 11). With the accent lighting system ON, the LED's will be energized and stay illuminated when the door is closed, in the DOOR position the lighting system will only be energized with the door opening.

NOTE:

- **WHEN LIGHTS ARE PLACED IN "ON" MODE, LIGHTS WILL NOT FADE-UP WHEN DOOR OPENS.**

FIGURE 11 - ACCENT LIGHTS ON/DOOR

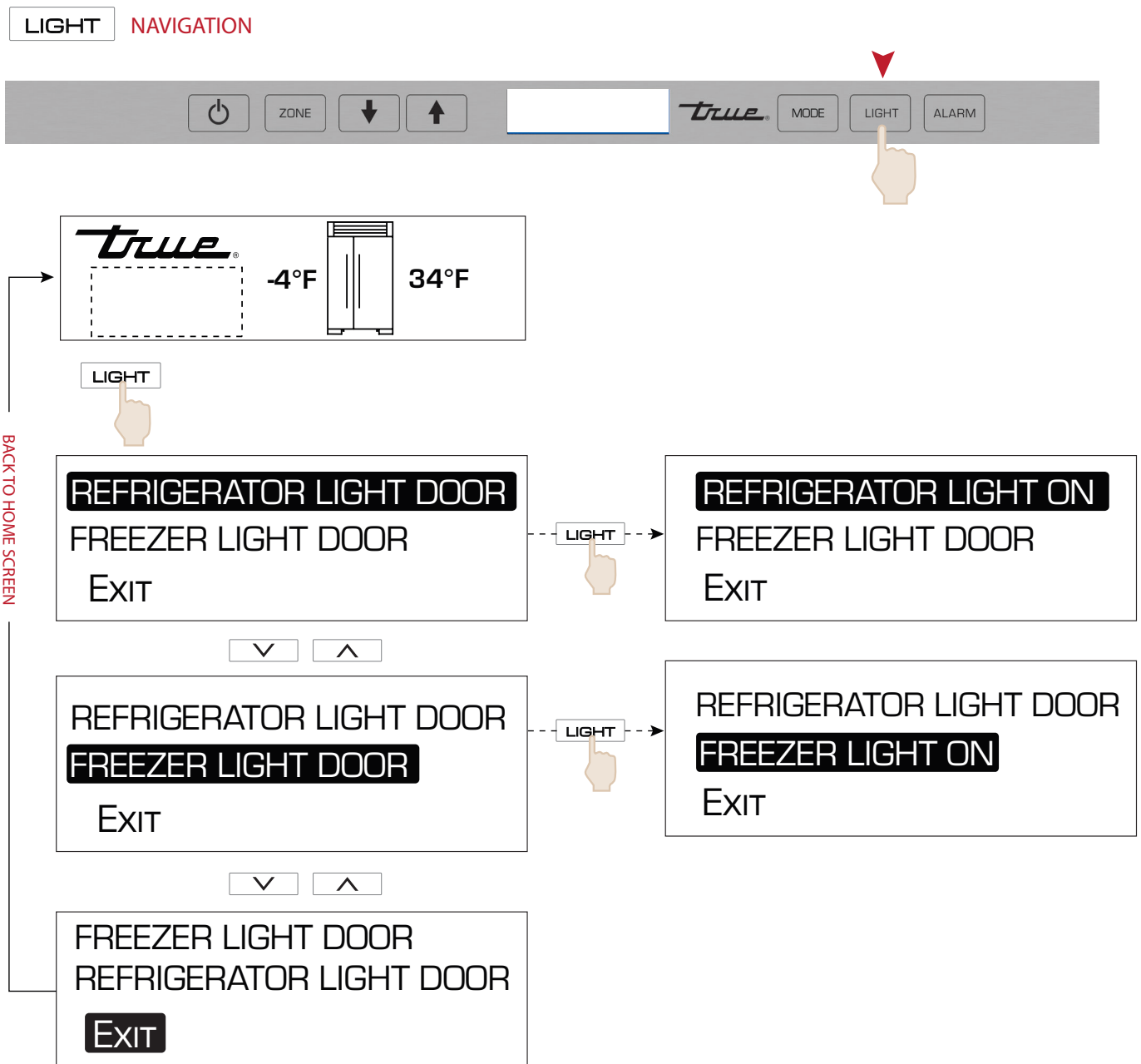

ALARM NAVIGATION (DOOR AJAR ALARM FEATURE ON/OFF)

All Residential Series units are equipped with a door ajar alarm feature. To enable the door ajar alarm, press the ALARM key on the control panel and “DOOR AJAR ALARM ON” will appear in the LCD indicating the alarm is enabled (See Figure 12). With the alarm enabled, the notification icons will appear and an audible alarm will beep continuously whenever a door is left open for more than 5 minutes. To disable the door ajar alarm, press the ALARM key again and “DOOR AJAR ALARM OFF” will appear in the LCD.

FIGURE 12 - ALARM NAVIGATION

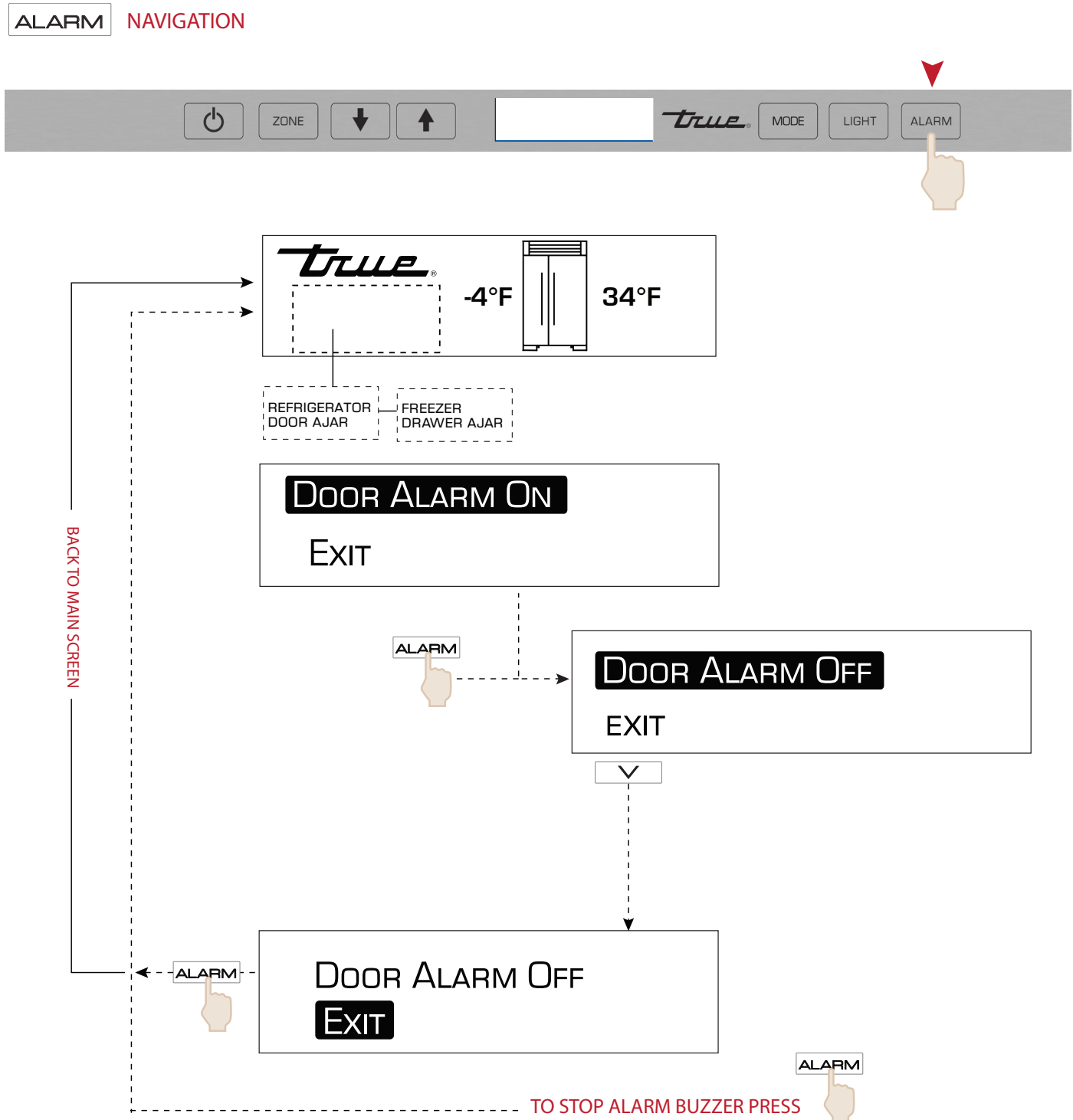

NOTIFICATION ALERTS

The diagrams on these pages illustrate what a customer may see in the LCD if the appliance needs attention (See Figure 13).

FIGURE 13 - NOTIFICATION ALERTS

NOTIFICATION ALERTS

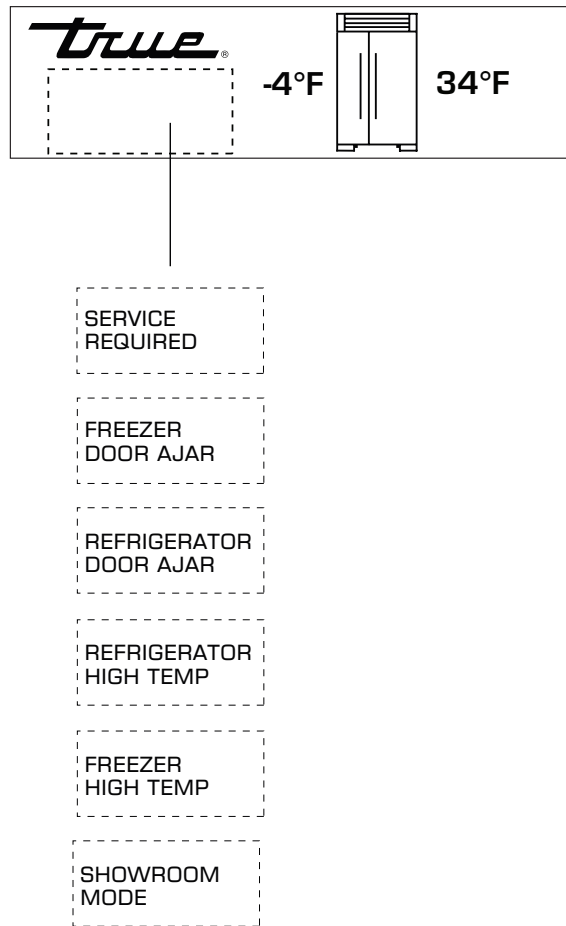

MAIN SCREEN COULD SHOW THE FOLLOWING COMMUNICATION ERROR:

COMMUNICATION ERROR
CALL FOR SERVICE

NOTES

SHELVING

REMOVING THE DOORS

KICK PLATE INSTALLATION



PRESERVE THE MOMENT™

SHELVING

All shelving and door bins come packaged inside the unit. (See Figure 14)



FIGURE 14

REFRIGERATOR STORAGE

GLASS SHELVES

Remove the top foam piece holding the glass shelves. Carefully remove shelves and set aside. (See Figure 15). Remove all other packing material. To install, insert glass shelf into the shelf standards on the back wall, with the front tilted upward, and then lower the front until it stops. (See Figure 16). To remove or adjust a glass shelf, tilt up, and then lift up and out.



FIGURE 15



FIGURE 16



Final Glass Shelf Installation

DOOR BINS

The door bins are located in the bottom drawer of the refrigerator. (See Figure 17). To install, push tabs into the slots in the door and slide downward until it stops. (See Figure 18). To remove or adjust a door bin, lift up and away from door back.

NOTE: BE CAUTIOUS OF PLACING TALL ITEMS IN TOP DOOR BIN, AS ITEMS MIGHT INTERFERE WITH UI CONTROL PANEL.



FIGURE 17

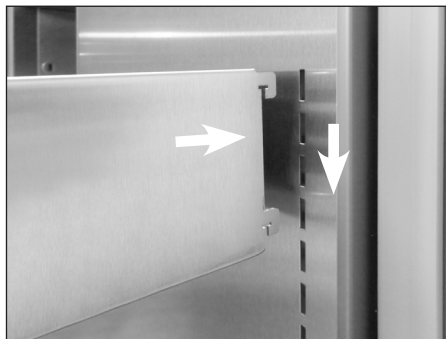

FIGURE 18



Final Door Bin Installation

DRAWERS

To remove a drawer, pull drawer forward until it stops. Use a Phillips screw driver to remove the two (2) screws securing the drawer to the slides, then lift the drawer up and out of unit. (See Figure 19). To reinstall, pull drawer slides all the way forward on unit, and then slide the drawer onto the slides until the hook on the back of the slide is over top of the drawer, reinstall the screws using the Phillips screw driver.



Figure 19

FREEZER STORAGE

WIRE SHELVES

Remove the top foam piece holding the wire shelves. Carefully remove shelves and set aside. (See Figure 20). Remove all other packing material. To install, insert wire shelf into the shelf standards on the back wall, with the front tilted upward, and then lower the front until it stops. (See Figure 21). To remove or adjust a wire shelf, tilt up, and then lift up and out.



FIGURE 20



FIGURE 21



Final Wire Shelf Installation

WIRE BASKETS

To remove a basket, pull drawer forward until it stops. Use a Phillips screw driver to remove the two (2) screws securing the basket to the slides, then lift the basket up and out of unit. To reinstall, pull drawer slides all the way forward on unit, and then slide the basket onto the slides until the hook on the back of the slide is over top of the rails, reinstall the screws using the Phillips screw driver. (See Figure 22).



Figure 22

REMOVING THE DOORS

REMOVING THE DOORS

Open the door to 90 degrees. (See Image 23). Lift the door straight up and out of the hinges. (See Image 24). To re-install, hold the door 90 degrees to the opening and align hinge posts to the hinges. Lower the door into place.



FIGURE 23



FIGURE 24

KICK PLATE INSTALLATION

KICK PLATE

The kick plate is shipped with the unit but not attached to allow access to level the unit (See Image 25). Once the unit is level, the kick plate attaches to the front, bottom of the unit with magnets located on the left and right. (See Image 26).

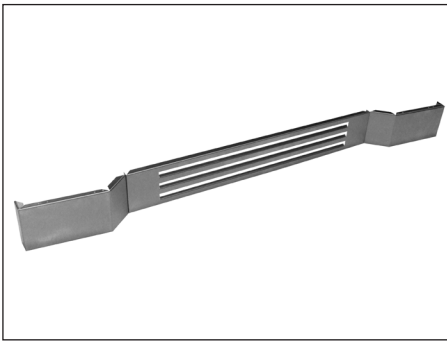

FIGURE 25

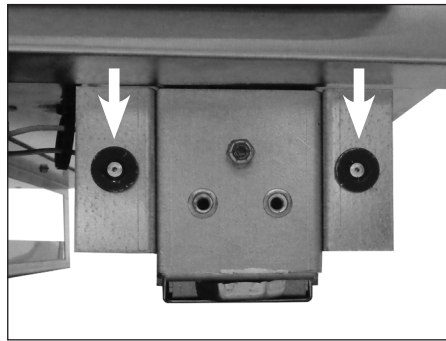

FIGURE 26 - Magnets



Installed Kick Plate

STAINLESS STEEL EQUIPMENT CARE AND CLEANING

GENERAL MAINTENANCE

WARRANTY

CONTACT INFORMATION



PRESERVE THE MOMENT™

STAINLESS STEEL EQUIPMENT CARE AND CLEANING

CAUTION: DO NOT USE ANY STEEL WOOL, ABRASIVE OR CHLORINE BASED PRODUCTS TO CLEAN STAINLESS STEEL SURFACES.

STAINLESS STEEL OPPONENTS

There are three basic things which can break down your stainless steel's passivity layer and allow corrosion to rear its ugly head.

1. Scratches from wire brushes, scrapers, and steel pads are just a few examples of items that can be abrasive to stainless steel's surface.
2. Deposits left on your stainless steel can leave spots. You may have hard or soft water depending on what part of the country you live in. Hard water can leave spots. Hard water that is heated can leave deposits if left to sit too long. These deposits can cause the passive layer to break down and rust your stainless steel.
All deposits left from food prep or service should be removed as soon as possible.
3. Chlorides are present in table salt, food, and water. Household and industrial cleaners are the worst type of chlorides to use.

RECOMMENDED CLEANERS FOR CERTAIN SITUATIONS / ENVIRONMENTS OF STAINLESS STEEL

- A. Soap, ammonia and detergent medallion applied with a cloth or sponge can be used for routine cleaning.
- B. Arcal 20, Lac-O-Nu Ecoshine applied provides barrier film for fingerprints and smears.
- C. Cameo, Talc, Zud First Impression is applied by rubbing in the direction of the polished lines for stubborn stains and discoloring.
- D. Easy-off and De-Grease It oven aid are excellent for removals on all finishes for grease-fatty acids, blood and burnt-on foods.
- E. Any good commercial detergent can be applied with a sponge or cloth to remove grease and oil.
- F. Benefit, Super Sheen, Sheila Shine are good for restoration / passivation.

NOTE: THE USE OF STAINLESS STEEL CLEANERS OR OTHER SUCH SOLVENTS IS NOT RECOMMENDED ON PLASTIC PARTS. WARM SOAP AND WATER WILL SUFFICE.

8 STEPS THAT CAN HELP PREVENT RUST ON STAINLESS STEEL:

1. USING THE CORRECT CLEANING TOOLS

Use non-abrasive tools when cleaning your stainless steel products. The stainless steel's passive layer will not be harmed by soft cloths and plastic scouring pads. Step 2 tells you how to find the polishing marks.

2. CLEANING ALONG THE POLISH LINES

Polishing lines or "grain" are visible on some stainless steels. Always scrub parallel to visible lines on some stainless steels. Use a plastic scouring pad or soft cloth when you cannot see the grain.

3. USE ALKALINE, ALKALINE CHLORINATED OR NON-CHLORIDE CONTAINING CLEANERS

While many traditional cleaners are loaded with chlorides, the industry is providing an ever increasing choice of non-chloride cleaners. If you are not sure of your cleaner's chloride content contact your cleaner supplier. If they tell you that your present cleaner contains chlorides, ask if they have an alternative. Avoid cleaners containing quaternary salts as they can attack stainless steel, causing pitting and rusting.

4. WATER TREATMENT

To reduce deposits, soften the hard water when possible. Installation of certain filters can remove corrosive and distasteful elements. Salts in a properly maintained water softener can be to your advantage. Contact a treatment specialist if you are not sure of the proper water treatment.

5. MAINTAINING THE CLEANLINESS OF YOUR FOOD EQUIPMENT

Use cleaners at the recommended strength (alkaline chlorinated or non-chloride). Avoid build-up of hard stains by cleaning frequently. When boiling water with your stainless steel equipment, the single most likely cause of damage is chlorides in the water. Heating any cleaners containing chlorides will have the same damaging effects.

6. RINSE

When using chlorinated cleaners you must rinse and wipe dry immediately. It is better to wipe standing cleaning agents and water as soon as possible. Allow the stainless steel equipment to air dry. Oxygen helps maintain the passivity film on stainless steel.

7. HYDROCHLORIC ACID (MURIATIC ACID) SHOULD NEVER BE USED ON STAINLESS STEEL

8. REGULARLY RESTORE/PASSIVATE STAINLESS STEEL

GENERAL MAINTENANCE

Keeping the condenser coil clean will minimize required service and lower electrical cost. The condenser coil is accessible from the front. (See Figure 27).

The condenser coil should be cleaned by removing dust and other build-up from the tube assembly with vacuum or a cleaning rag.

When properly cleaned you should be able to see through the tube assembly.

Warranty does not cover cleaning the condenser coil.



FIGURE 27

WARRANTY

LIMITED 30 DAY COSMETIC WARRANTY

Stainless steel doors, handles, and shelves are warranted to be free from defective materials or workmanship for a period of thirty (30) days from the date of original retail purchase. Any defects must be reported to the selling dealer within thirty (30) days from the date of original retail purchase. This limited warranty excludes any type of freight / concealed damage.

THREE-YEAR PARTS & LABOR WARRANTY *For units purchased after Feb. 1, 2013.

TRUE warrants to the original purchaser of every new TRUE refrigerated unit, the cabinet and all parts thereof, to be free from defects in material or workmanship under normal and proper use and maintenance as specified by TRUE and upon proper installation and start-up in accordance with the instruction packet supplied with each TRUE unit. TRUE's obligation under this warranty is limited to a period of three (3) years from the date of original installation or thirty nine (39) months after shipment date from TRUE, whichever occurs first.

SIX-YEAR SEALED SYSTEM WARRANTY - PARTS & LABOR *For units purchased after Feb. 1, 2013.

TRUE warrants its hermetically sealed system: compressor, evaporator coil, condenser coil, drier, metering device and connecting tubing to be free from defects in both material and workmanship under normal and proper use and maintenance service for a period of six (6) years from the date of original installation but not to exceed six (6) years and three (3) months after shipment from the manufacturer, whichever occurs first.

TERMS APPLICABLE TO EACH WARRANTY

Any part covered under the above warranties that is determined by TRUE to have been defective within the time frame is limited to the repair or replacement, including labor charges, of defective parts or assemblies. The labor warranty shall include standard straight time labor charges only and reasonable travel time, as determined by TRUE.

WARRANTY CLAIMS

All claims for labor or parts must be made directly through TRUE. All claims should include: model number and serial number of cabinet, proof of purchase, and date of installation. In case of warranted compressor, the compressor model tag must be returned to TRUE along with the above listed information.

WHAT IS NOT COVERED BY THIS WARRANTY

TRUE's sole obligation under this warranty is limited to either repair or replacement of parts, subject to the additional limitations below. This warranty neither assumes nor authorizes any person to assume obligations other than those expressly covered by this warranty.

NO CONSEQUENTIAL DAMAGES. TRUE is not responsible for economic loss, profit loss; or special, indirect or consequential damages, including without limitation, losses or damages arising from food or product spoilage claims whether or not on account of refrigeration failure.

WARRANTY IS NOT TRANSFERABLE. This warranty is not assignable and applies only in favor of the original purchaser/ user to whom delivered. Any such assignment or transfer shall void the warranties herein made and shall void all warranties, express or implied, including any warranty of merchantability or fitness for a particular purpose.

IMPROPER USAGE. TRUE assumes no liability for parts or labor coverage for component failure or other damages resulting from improper usage or installation or failure to clean and/or maintain product as set forth in the warranty packet provided with the unit.

ALTERATION OR NEGLECT. TRUE is not responsible for the repair or replacement of any parts that TRUE determines have been subjected after the date of manufacture to alteration, neglect, abuse, misuse, accident, damage during transit or installation, fire, flood, or act of God.

IMPROPER ELECTRICAL CONNECTIONS. TRUE is not responsible for the repair or replacement of failed or damaged components resulting from electrical power failure, high or low voltage, use of extension cords, or improper grounding of the unit.

NO IMPLIED WARRANTY. There are no other warranties, expressed, implied or statutory except the 30 day cosmetic, 3-year parts and labor and 6-year sealed system warranty as described above. These warranties are exclusive and in lieu of all other warranties, including implied warranty and merchantability or fitness for a particular purpose. There are no warranties which extend beyond the description on the face hereof.

Some states do not allow the exclusion or limitation of consequential damages or a limitation on how long an implied warranty lasts, so the above exclusion or limitation may not apply to you. This warranty gives you specific legal rights and you may have other rights that vary from state to state.

OUTSIDE U.S./CANADA. This warranty does not apply to, and TRUE is not responsible for, any warranty claims made on products sold or used outside the United States or Canada.

CONTACT INFORMATION

Please have your serial # on hand so we can better assist you. The serial # is a 7-digit number located on the left hand side wall by the pull out wire basket located in the freezer section of your unit.

Customer Service

P# 888-616-8783

Website – www.true-residential.com

Warranty Department

P# - 844-849-6179

Website – trueresidentialwarranty@truemfg.com

Service Department

P# 844-746-9423

Website - service@truemfg.com

CONTACT US
www.true-residential.com
toll free (888)616-8783

